



ISO 9001

RoHS

Electrical Apparatus Capacitors

# 電器用電容器

## Electrical Apparatus Capacitors



裕昌機電工廠股份有限公司  
YUHCHANG ELECTRIC CO., LTD.

# Company Profile

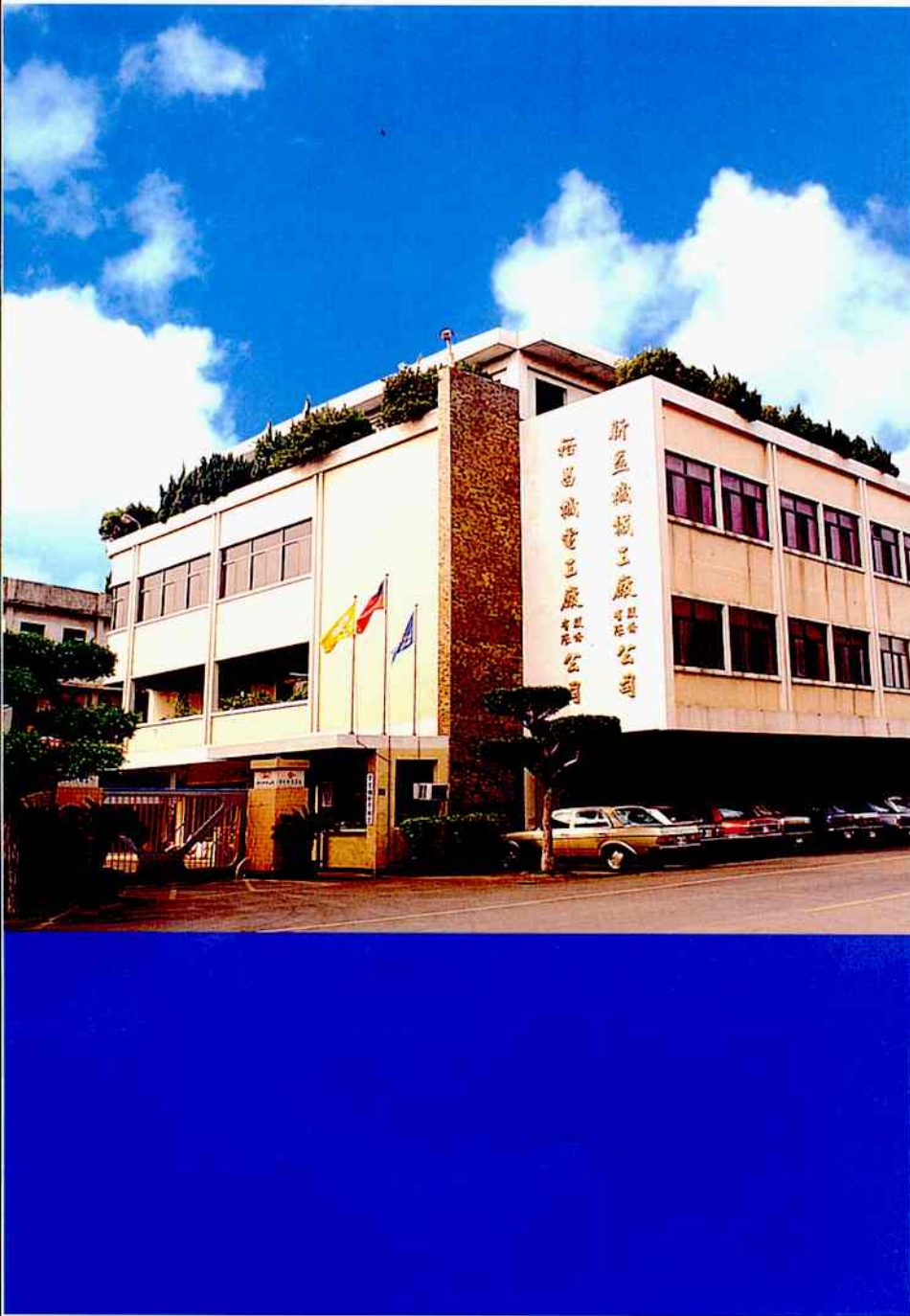

## 公司簡介

創 立：1967年4月  
地 址：台灣·台中縣清水鎮中正街59號  
資 本 額：新台幣捌仟萬元整(美金250萬元)  
負 責 人：林秋雄  
員工人數：130人  
主要產品：  
電力用高低壓電容器、乾式低壓電容器  
感應爐用電容器、UV乾燥機用電容器  
馬達運轉用電容器、照明燈具用電容器  
自動功率因素調整盤及調整器、串聯電抗器  
關係企業：  
新益機械工廠股份有限公司  
鋒益機械工廠股份有限公司

## Company Profile

**Foundation** : Established in April, 1967  
**Address** : No. 59, Chung Cheng St., Ching Shui, Taichung, Taiwan  
**Capital** : NT\$80 million (US\$ 2.5 million)  
**President** : C. H. Lin  
**Employees** : 130 persons  
**Main Products** :  
High/Low Voltage Power Capacitors  
Dry Type Low Voltage Capacitors  
Capacitors for Induction Furnaces  
Capacitors for UV Curing Equipments  
Motor Running Capacitors  
Lighting Capacitors  
Automatic Capacitor Banks  
Automatic Power Factor Regulators(APFR)  
Series Reactors  
**Group Companies** :  
Shin-I Machinery works Co., Ltd.  
Fong Yin Machinery Industry Co., Ltd.

# 目錄 Contents

	PAGE 頁次
● 製品規範及性能 / <b>Specification and Performance</b> .....	1
蒸著金屬塑膠膜電氣特性 / Electrical Properties of Metallized Film.....	2
自復性機能 / Self-healing Mechanism.....	2
● 保安性 / <b>Safety</b> .....	3
保安機構動作原理 / Operation of Internal Safety Mechanism.....	3
保安裝置動作原理 / Operation of Internal Protective Device.....	4
● 產品種類 / <b>Product Categories</b> .....	5
方形系類 / Box Style.....	5
圓形系類 / Round Style.....	7
保安型系類 / Safety Type.....	8

## ■ 製品規範及性能 / Specification and Performance :

類別(Category) 性能(Performance)	馬達用電容器 Motor Running Capacitors	照明器具用電容器 Lighting Capacitors
依據標準 (Standards)	IEC 60252-1; CNS 4327; JIS C 4908	IEC 61048, IEC 61049; CNS 4327; JIS C 4908
用途 (Application)	冷氣空調、電冰箱、洗衣機、送風機、風扇馬達等起動運轉用。 For motor starting and running of air condition machines, refrigerators, washing machines, ventilators, electric fans, etc.	日光燈及放電燈電路用 For use in tubular fluorescent and discharge lamp circuits.
適用高度 (Usable altitude)	海拔2000公尺以下 Max above sea level 2000M	海拔3000公尺以下 Max above sea level 3000M
頻率 (Frequency)	50/60Hz	
容量誤差 (Tolerance)	(K) ± 10% (U)+10%~-5% (J) ± 5%	
使用溫度 Operating temperature	最低使用溫度(Minimum temperature): -40°C or -25°C 最高使用溫度(Maximum temperature): 55°C, 70°C, 85°C, or 100°C [其他溫度種類可訂製] / [Other operating temperature categories on request]	
最大容許過電壓 Maximum permissible voltage	額定電壓x1.1 1.1 x rated voltage	
最大容許過電流 Maximum permissible current	額定電流x 1.3 1.3 x rated current	
最大容許過載容量(kVAR) Maximum permissible output(kVAR)	額定kVAR之135% 1.35 x rated kVAR	
電介質 Dielectric	聚丙烯膜(PP)或聚乙酯膜( PET) Polypropylene (PP) film or Polyester (PET) film	
電容器損失率 Dissipation factor (at 20°C 60Hz)	電介質PP (Dielectric PP): < 0.1% 電介質PET (Dielectric PET): < 0.3%	
端子間耐電壓 Test voltage between terminals	額定電壓 × 2 VAC，施加2秒鐘 Applied rated voltage x 2 VAC for 2 seconds	
端子與外殼間耐電壓 Test voltage between terminals and case	額定電壓 × 2+1000VAC (最低2000VAC)，施加1分鐘。 Applied rated voltage x 2+1000VAC (minimum 2000VAC) for 1 minute.	
絕緣電阻 Insulation resistance	端子與外殼間2000MΩ以上 Above 2000MΩ between terminals and case	
放電特性 (附加電阻者) Discharge character (Only for capacitor with discharge resistor)	電容器切離電源1分鐘後，殘餘電壓降至50V以下。 The residual voltage drops to 50V or lower in 1 minute after capacitor being disconnected from power source.	
保安性 (內附保安機構或裝置者) Safety (Only for capacitors with safety mechanism or protective device)	<ol style="list-style-type: none"> <li>1. 保安機構：電容器元件採用具熔絲設計之區塊式金屬化聚丙烯膜捲繞而成，當元件內部發生異狀時，異常區塊之熔絲會熔斷與電源分離，使其它正常區塊可維持電容器正常運作。 Safety mechanism: capacitor element wound by segment metallized polypropylene film with internal fuses. When element had internal failure, the fuses of failure segments would be blow to separate failure area from power source. The reset normal segments can keep capacitor working well.</li> <li>2. 保安裝置：電容器內裝壓力拉斷型保安裝置，具過載及故障保護機能。 Protective device: capacitor equipped internal protective device (pressure sensitive interrupter) with overload and failure protection.</li> <li>3. 保安等級：P2 (依據 IEC 60252-1標準)，AFC 10,000A (依據 UL 810標準)。 Class of safety: P2 (according standard IEC 60252-1), AFC 10,000A (according standard UL 810).</li> </ol>	
產品認證 Quality approval	 RoHS	
工廠認證 Factory approval	ISO 9001	



# 蒸著金屬塑膠膜電氣特性 / Electrical Properties of Metallized Film

容量與溫度變化曲線

Capacitance Change vs. Temperature

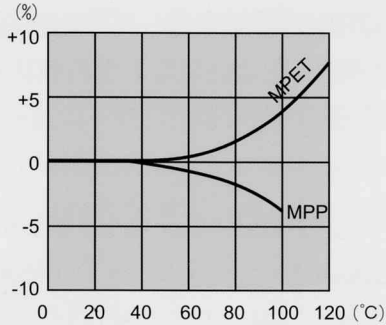

絕緣電阻值與溫度變化曲線

Insulation Resistance vs. Temperature

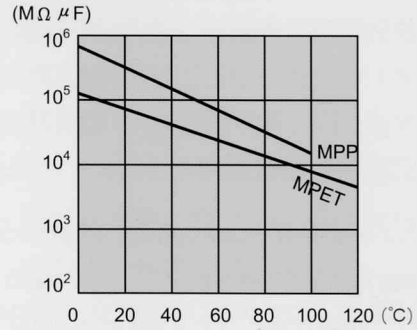

損失率與溫度變化曲線

Dissipation Factor vs. Temperature

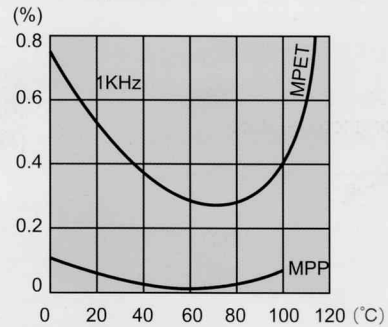
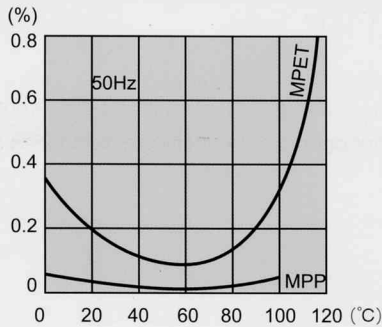

MPET: Metallized Polyester Film

MPP: Metallized Polypropylene Film

## 自復性機能 / Self-healing mechanism

電介質採用金屬化塑膠膜，當異常電壓發生而破壞介質時，破壞點附近之金屬膜瞬間消失，絕緣立即自動恢復。此自復作用將於數微秒內完成，使故障立即排除，電容器得以繼續使用。

Dielectric adopts metallized film as intermediate; in case excessive voltage takes place and damages the material, the metallized layer around the damaged spot will disappear instantly, and insulation is restored immediately.

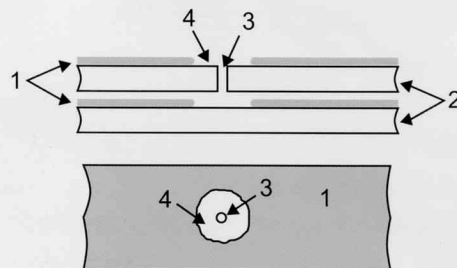

1. 蒸著金屬層 / Metallized layer
2. 塑膠膜 / Film
3. 絕緣破壞點 / Damaged spot
4. 自復範圍 / Self-healing range

## ■ 保安性 / Safety

### 保安機構動作原理 / Operation of Internal Safety Mechanism

電容器元件以節段式金屬化塑膠膜捲繞而成，使電容量由數百或數千個小容量並聯而成，且在每一個小容量上設計有類似保險絲功能的保安機構，如下圖1所示。當電容器承受過電壓、異常過溫或壽命終了時，造成絕緣材質破壞，部份小容量單元發生異常，導致保險絲熔斷，與電路分離，而其餘正常小容量單元仍然正常被使用，如下圖2所示。電容器功能不因局部異常而失去整只電容器的功能，以達自我保護功能，避免電容器發生冒煙或起火。

Capacitor element wounded by segmented metallized film. Hundreds or thousands of small capacitors in parallel formed the element, and each small capacitor equipped individual fuse as Figure 1. When a dielectric breakdown occurred in a small capacitor due to overvoltage, abnormal heating or end of life, the fuse of the failure area burned off and disconnected the failure area from circuit. The remained good small capacitors would continue to be used as Figure 2. Capacitor will not lose the function caused by partial failure. Its self-protective function will prevent capacitor from emitting smoke or catching fire.

圖1. 元件結構(正常情形)

Figure 1. Element Structure (Normal Condition)

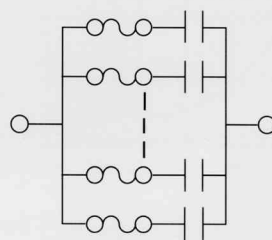
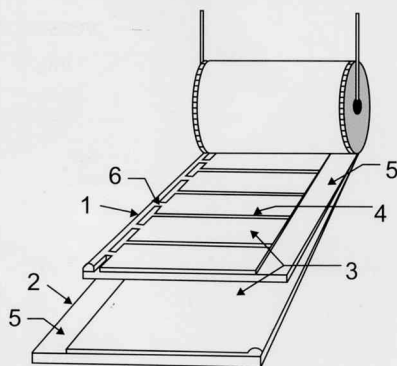

等效電路

Equivalent Circuit

圖2. 異常發生熔絲動作

Figure 2. Fuse burned off on failure area

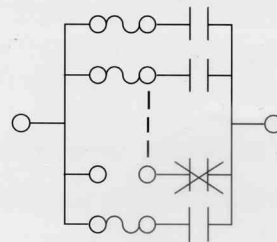

等效電路

Equivalent Circuit

1. 附保安機構之金屬化塑膠膜 (Segmented metallized film)
2. 一般金屬化塑膠膜 (General metallized film)
3. 蒸著金屬層 (Metallized layer)
4. 橫向間隔區 (Free margin in transverse direction)
5. 縱向間隔區 (Free margin in machine direction)
6. 保險絲 (Fuses)
7. 故障點 (Failure area)

### 保安裝置動作原理 / Operation of Internal Protective Device

當電容器內部故障或壽命即將終了前，會產生一連串自復性崩潰導致電容器元件內部壓力增大，為避免造成電容器外殼爆裂，每一電容器元件內部結構設計有壓力拉斷型電源切斷機構(保安裝置)。此保安裝置是藉由內壓增加造成上蓋鼓起使弱點處理之銅箔被拉斷與電源隔離，防止二次災害發生。

In the event of internal failure or aging at the end of the capacitor's operational life, an increasing number of self-healing breakdowns may cause rising pressure inside the capacitor element. To prevent it from bursting, each capacitor element is designed with internal pressure sensitive interrupter (Protective Device). With rising pressure the cover will bulge to disconnect copper taps at weak points from the cover, and the current path is interrupted irreversibly to avoid the relative disaster.

電容器上蓋平整，銅箔與上蓋端子連接。

Capacitor cover is normally flat, and the taps are connected to the terminals of cover.

保安裝置 / Protective Device

具弱點處理銅箔

Copper taps with weak point

電容器元件 / Capacitor roll

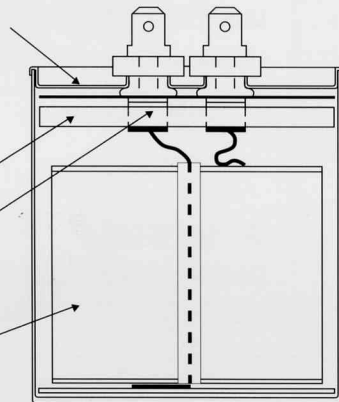

正常使用時(動作前)

Normal Condition

電容器內部故障內壓上升上蓋鼓起。  
Capacitor cover bulges as internal pressure increases on the event of an internal failure.

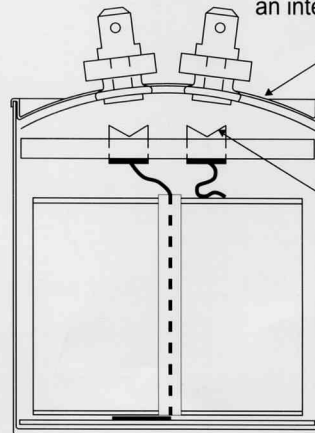









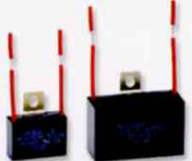

銅箔被拉斷與上蓋分離。  
Copper taps are disconnected from the cover by the pressure sensitive interrupter.

動作後

Operating Condition

## ■ 方形系類 / Box Style

防火塑殼，防火樹脂充填		Fire-retardant plastic case, Fire-retardant epoxy resin filling		
圖片 Pictures	型式 Model	用途 Application	特點 Features	認證 Certificate
	SCA	馬達啓動兼運轉 照明器具 電子設備  Motor running, Lighting, Electronic equipment	UL引出線 UL leads	    <b>RoHS</b>
	SCB		UL引出線，外殼附直型固定片。 UL leads, Case with Straight mounting tab.	
	SCC		UL引出線，外殼附彎角固定片。 UL leads, Case with angled mounting tab.	
	SCE		UL引出線，外殼附固定腳座。 UL leads, Case with integral mounting tab.	
	SFA		雙片快速插接端子 Double quick-connect terminals	
	SFB		雙片快速插接端子，外殼附直型固定片。 Double quick-connect terminals, Case with straight mounting tab.	
	SFE		雙片快速插接端子，外殼附固定腳座。 Double quick-connect terminals, Case with integral mounting tab.	
	SFE-1		單片快速插接端子(兩片直線排列)， 外殼附固定腳座。 Single quick-connect terminals (terminals aligned in a line), Case with integral mounting tab.	
	SFE-N		快速插接端子(兩片平行排列)， 外殼附固定腳座。 Single quick-connect terminals (terminals aligned in parallel), Case with integral mounting tab.	



## 方形系類 / Box Style

防火塑殼，防火樹脂充填		Fire-retardant plastic case, Fire-retardant epoxy resin filling		
圖片 Pictures	型式 Model	用途 Application	特點 Features	認證 Certificate
	SGA		焊線用端子 Soldering terminals	  <b>RoHS</b>
	SGB	馬達啟動兼運轉 照明器具 電子設備	焊線用端子，外殼附直型固定片。 Soldering terminals, Case with straight mounting tab.	
	SGC	Motor running, Lighting, Electronic equipment	焊線用端子，外殼附彎角固定片。 Soldering terminals, Case with angled mounting tab.	
	SGE		焊線用端子，外殼附固定腳座。 Soldering terminals, Case with integral mounting tab.	
	SWA	電磁爐、馬達啟動兼運轉、 照明器具、電力電子設備 Induction cooker, Motor running, Lighting, Power electronic equipment	鍍錫裸銅線 Tinned copper wires	
	SPA	電磁爐 電力電子設備	焊接用鍍錫銅端子 Tinned copper terminals for soldering	 <b>RoHS</b>
	SLE	Motor running, Power electronic equipment	鎖螺絲型銅端子，防火塑殼附固定腳座。 Screwing terminals, Case with integral mounting tab.	
	FT	電子設備	扁形，鍍錫裸銅線或UL電線， 防火膠帶，防火樹脂充填。 Flat style, Tinned copper wires or UL leads, Fire-retardant taping, Fire-retardant epoxy resin filling.	
	YT	Electronic equipment	圓形，鍍錫裸銅線或UL電線，防火膠帶， 防火樹脂充填。 Round style, Tinned copper wires or UL leads, Fire-retardant taping, Fire-retardant epoxy resin filling.	







## 圓形系類 / Round Style

防火塑殼或鋁殼		Fire-retardant plastic case, or aluminum case		
圖片 Pictures	型式 Model	用途 Application	特點 Features	認證 Certificate
	YC		UL引出線，防火塑殼或鋁殼，防火樹脂充填。 UL leads, Fire-retardant plastic case or aluminum case, Fire-retardant epoxy resin filling.	  
	YC+B	馬達啓動兼運轉 照明器具 電子設備  Motor running, Lighting, Electronic equipment	UL引出線，防火塑殼或鋁殼，底部附固定用螺絲，防火樹脂充填。 UL leads, Fire-retardant plastic case or Aluminum case, Mounting stud on the bottom, Fire-retardant epoxy resin filling.	
	YF		快速插接端子，鋁殼附絕緣膜。 Quick-connect terminals, Aluminum case with PVC tube.	
	YF+B		快速插接端子，鋁殼附絕緣膜，底部附固定用螺絲。 Quick-connect terminals, Aluminum case with PVC tube, Mounting stud on the bottom.	
	RBC		四線插接式端子蓋內附放電電阻，鋁殼附絕緣膜。 Four-way wire-grip connector with internal discharge resistor, Aluminum case with PVC tube.	
	RC	照明器具 Lighting	四線插接式端子蓋內附放電電阻，防火塑殼。 Four-way wire-grip connector with internal discharge resistor, Fire-retardant plastic case.	
	RC+B		四線插接式端子蓋內附放電電阻，防火塑殼，底部附固定用螺絲。 Four-way wire-grip connector with internal discharge resistor, Fire-retardant plastic case, Mounting stud on the bottom.	

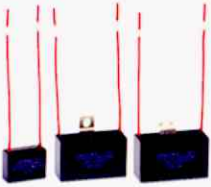
## 保安型系類 / Safety Type

UL 810 認證 容許故障電流10,000A / 保安等級 P2

UL 810 approval with AFC 10,000A and Safety class P2

圖片 Pictures	型式 Model	用途 Application	特點 Features	認證 Certificate
	SCA SCB SCE	馬達啓動兼運轉 照明器具 電力電子設備  Motor running, Lighting, Power electronic equipment	方形，UL引出線，防火塑殼，防火樹脂充填。SCB型：外殼附固定片。SCE型：外殼附固定腳。 Box style, UL leads, Fire-retardant plastic case, Fire-retardant epoxy resin filling. Type SCB: case with mounting tab Type SCE: case with integral mounting tab	RoHS
	SFA SFB SFE		方形，快速插接端子，防火塑殼，防火樹脂充填。SFB型：外殼附固定片。SFE型：外殼附固定腳。 Box style, Quick-connect terminals, Fire-retardant plastic case, Fire-retardant epoxy resin filling. Type SFB: case with mounting tab Type SFE: case with integral mounting tab	
	SWA		方形，鍍錫裸銅線，防火塑殼，防火樹脂充填。 Box style, Tinned copper wires, Fire-retardant plastic case, Fire-retardant epoxy resin filling.	
	YFP		圓形，快速插接端子，鋁質外殼，內附保安裝置。 Round style, Quick-connect terminals, Aluminum case, Internal protective device.	
	YFP+B		圓形，快速插接端子，鋁質外殼，內附保安裝置。外殼底有附固定用螺絲。 Round style, Quick-connect terminals, Aluminum case, Internal protective device, Case with mounting stud on the bottom.	
	RFP		橢圓形，快速插接端子，鋁質外殼，內附保安裝置。 Oval style, Quick-connect terminals, Aluminum case, Internal protective device.	
	RBC		圓形，四線插接式端子蓋內附放電電阻，鋁殼附絕緣膜。 Round style, four-way wire-grip connector with internal discharge resistor, Aluminum case with PVC tube.	

## 主要產品 Main Products

1. 電力用高低壓電容器 High / Low Voltage Power Capacitors
2. 乾式低壓電容器 Dry Type Low Voltage Capacitors
3. 感應爐用電容器 Capacitors for Induction Furnaces
4. UV乾燥機用電容器 Capacitors for UV Curing Equipments
5. 馬達運轉用電容器 Motor Running Capacitors
6. 照明燈具用電容器 Lighting Capacitors
7. 自動功率因數調整盤 Automatic Capacitors Banks
8. 自動功率因數調整器 Automatic Power Factor Regulators(APFR)
9. 串聯電抗器 Series Reactors



**裕昌機電工廠股份有限公司**  
**YUHCHANG ELECTRIC CO., LTD.**

總公司：台灣·台中縣清水鎮中正街59號 Tel:04-26224188 Fax:04-26224646  
台北連絡處：台北市復興南路1段321號二樓 Tel:02-27021616 Fax:02-27066162  
桃園連絡處：桃園市建國路99之8號 Tel:03-3665566 Fax:03-3619988  
高雄連絡處：高雄市復興一路5之1號 Tel:07-2417766 Fax:07-2915282

ADD : No. 59, Chung Cheng St, Chingshui, Taichung, Taiwan  
Tel : 886-4-26224188 Fax:886-4-26224646  
Web : <http://www.capacitor.com.tw>  
E-mail : [yce919@ms1.hinet.net](mailto:yce919@ms1.hinet.net)