

改善功率因數用 <<<<<<<<

低壓電力電容器

Low Voltage Power Capacitors



裕昌機電工廠股份有限公司
YUHCHANG ELECTRIC CO., LTD.



公司簡介 Company Profile

創 立：1967年4月

地 址：台灣·台中市清水區中正街59號

資 本 額：新台幣捌千萬元整(美金250萬元)

負 責 人：林秋金

員工人數：125人

主要產品：

電力用高低壓電容器、乾式低壓電容器

感應加熱爐用電容器、UV乾燥機用電容器

馬達運轉用電容器、照明燈具用電容器

自動功率因數調整盤及調整器、串聯電抗器

關係企業：

新益機械工廠股份有限公司

Foundation : Established in April, 1967

Address : No. 59, Chung Cheng Street,
Ching Shui District, Taichung City, Taiwan

Capital : NT\$80 million (US\$2.5 million)

President : C. J. Lin

Employees : 125 persons

Main Products :

High / Low Voltage Power Capacitors

Dry Type Low Voltage Capacitors

Induction Heating Furnace Capacitors

Capacitors for UV Curing Equipments

Motor Running Capacitors

Lighting Capacitors

Automatic Capacitor Banks

Automatic Power Factor Regulators(APFR)

Series Reactors

Group Companies :

Shin-Machinery works Co., Ltd.

目錄

Contents >>>

- 製品規範及性能 3
Specification and Performance
- 油式低壓電容器 (保安型) 5
Oil-type Low Voltage Power Capacitors (Safety)
- 乾式低壓電容器 (鐵殼M型) 9
Dry-type Low Voltage Power Capacitors
(Steel box M-series)
- 充氣式乾式低壓電容器 (鋁殼C型) 13
Gas-Filled Dry-Type Low Voltage Power Capacitors
(Aluminum can C-series)
- 選購須知 15
Selection and Recommend
- 使用注意事項 16
Cautions for Installation
- 維護保養 17
Maintenance
- 電容器裝置容量計算係數表 18
Calculation coefficients of capacity for capacitor
to be installed





低壓電力電容器 >>>>

製品規範及性能 / Specification and Performance

依據標準 Standards	CNS 1179, 3738; IEC 60831; JIS C 4901
產品認證 Quality approval	正字標記認證 (台正字第2845號) CNS mark (No. 2845)
工廠認證 Factory approval	ISO 9001(2008年版) 認證 ISO 9001:2008 certificated
適用高度 Usable altitude	海拔2000公尺以下；乾式屋內型相對濕度95%以下 Not exceeding 2000M; Relative Humidity below 95% for dry-type and indoor use capacitors.
電介質 Dielectric	蒸著金屬聚丙烯塑膠膜，具自復性機能 Metallized polypropylene film with self-healing mechanism.
絕緣油 Insulation oil	油式：精製植物油（無PCB） Vegetable oil (Non-PCB) for oil type 乾式：無 No oil for dry type
頻率 Frequency	60Hz
容量誤差 Tolerance	-5%~+10%
周圍溫度 Ambient temperature	-25°C~+50°C (24小時平均溫度小於40°C，一年平均溫度小於30°C) [其他溫度種類可訂製] -25°C~+50°C (24hours average below 40°C, annual average below 30°C) [Other ambient temperature categories on request]
最大容許過電壓 Maximum permissible voltage	額定電壓110% (24小時中8小時以內) 110% of rated voltage (8 hrs in every 24 hrs) 額定電壓115% (24小時中30分鐘以內) 115% of rated voltage (30 min in every 24 hrs) 額定電壓120% (5分鐘，最多200次) 120% of rated voltage (5 min / max 200 times) 額定電壓130% (1分鐘，最多200次) 130% of rated voltage (1 min / max 200 times)
最大容許過電流 Maximum permissible current	額定電流130% 130% of rated current
介質損失率 Dissipation factor of dielectric	小於0.02% 或 0.2W / kVAR (不含放電電阻) Less than 0.02% or 0.2W / kVAR (without discharge resistors)
電容器損失率 Dissipation factor of capacitor	小於0.15% 或 1.5W / kVAR (含放電電阻) Less than 0.15% or 1.5W / kVAR (with discharge resistors)
端子間耐電壓 Test voltage between terminals	額定電壓×2.15VAC，施加10秒 Rated voltage x 2.15 Vac, 10 second
端子與外殼間耐電壓 Test voltage between terminals and case	屋內型：3000VAC，施加1分鐘 / 3000VAC, 1 minute (For indoor use) 屋內外型：10kVAC，施加1分鐘 / 10kVAC, 1 minute (For indoor & outdoor use)
衝擊電壓(BIL) Impulse voltage (BIL)	屋內外型(indoor & outdoor use): 30kV (1.2×50 μS)
絕緣電阻(T-C) Insulation resistance	1000MΩ 以上 above 1000MΩ
放電特性 Discharge character	電容器切離電源1分鐘後，殘餘電壓降至50V以下 The residual voltage drops to 50V or lower in 1 minute after capacitor being disconnected from power source.
保安性 Safety	內裝壓力拉斷型保安裝置具過載及故障保護機能，通過UL 810之AFC 10000A認證，案號E112211。 Internal protective device (Pressure sensitive interrupter) with overload and failure protection. UL 810 AFC 10000A approval, File NO. E112211.
容許湧入電流 Max Inrush current	額定電流×200倍 Rated current x 200
保護等級 Degree of protection	乾式M型：IP 50 IP 50 for dry M type 乾式C型：IP 20 IP 20 for dry C type 油式屋內型：IP 50 IP 50 for oil type indoor use

蒸著金屬聚丙烯塑膠膜電氣特性

The electrical properties of metallized polypropylene film

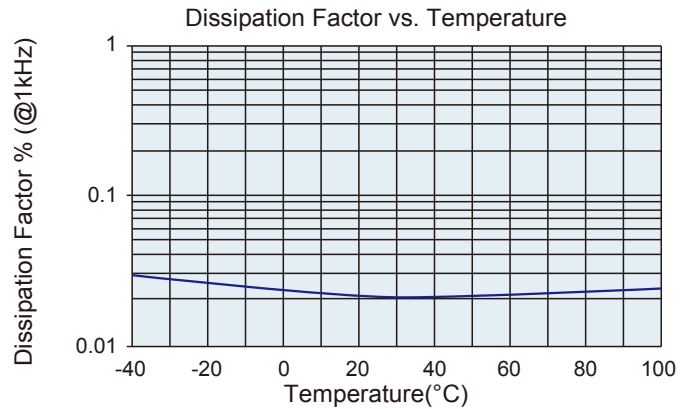
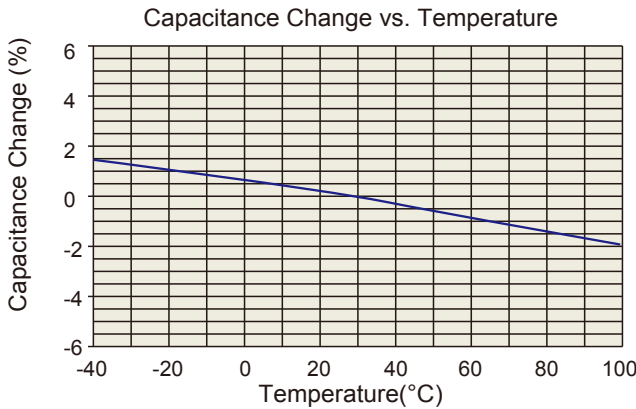

電容器元件 Capacitor element

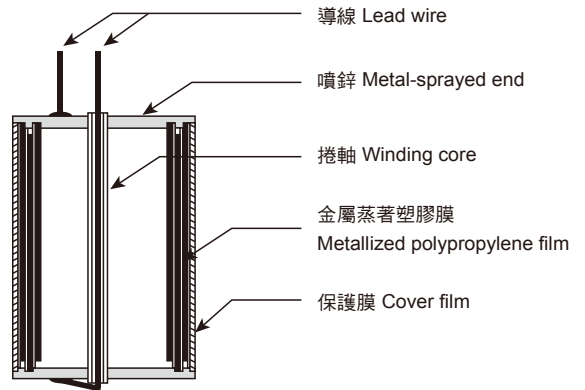
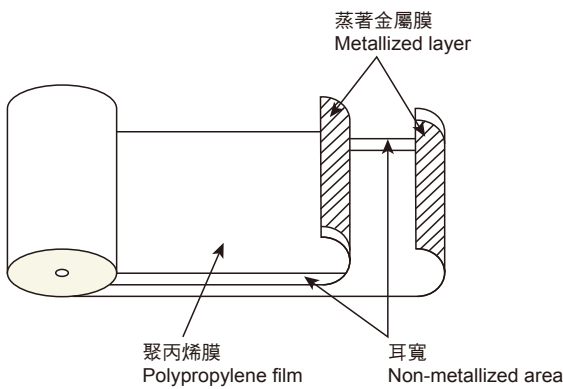

自復性機能 Self-healing mechanism

電介質採用金屬化塑膠膜 (Metallized Polypropylene Film)，當異常電壓發生而破壞介質時，破壞點附近之金屬膜瞬間消失，絕緣立即自動恢復。此自復作用將於數微秒內完成，使故障立即排除，電容器得以繼續使用

Dielectric adopts metallized polypropylene film as intermediate; in case excessive voltage takes place and damages the material, the metallized layer around the damaged spot will disappear instantly, and insulation is restored immediately

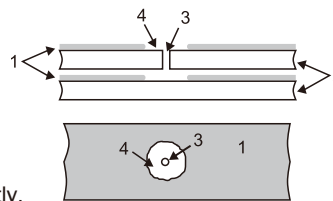

1. 蒸著金屬層 / Metallized layer
2. 聚丙烯塑膠膜 / Polypropylene film
3. 絕緣破壞點 / Damaged spot
4. 自復範圍 / Self-healing range

型式說明 / Type Formation

Y □ M □ - □□ K □□ □ □□
1 2 3 4 5 6 7 8 9 10

1. 裕昌牌	1. Yuhchang brand
2. 外殼形狀: S 為方形, R 為橢圓形, Y 為圓柱形	2. Case style: S is box, R is oval, Y is cylindrical
3. 電容器元件材料為蒸著金屬膜	3. Material of capacitor elements is Metallized film
4. 頻率: A 為60Hz, B 為50Hz	4. Frequency: A is 60Hz, B is 50Hz
5. 額定電壓以電壓值÷10表示	5. Rated voltage is represented by voltage/10
6. 額定容量以kvar為單位	6. Unit of capacity in kvar
7. 額定容量kvar值	7. Value of kvar capacity
8. 相數: S 為單相, T 為三相	8. Phase: S is single phase, T is three phases
9. D 為乾式電容器, 油式電容器此碼不用 G 為充氣式乾式電容器	9. D for dry type capacitors, No use this code only for oil type capacitors G for gas-filled dry type capacitors
10. M 為乾式金屬外殼, C 為圓柱形鋁罐 油式電容器此碼不用	10. M for dry type capacitor with metal case C for dry type capacitor with cylindrical Aluminum can. No use this code for oil type capacitors.



油式低壓電容器 《保安型》 >>>>

金屬外箱 / 內裝保安裝置 / 內附放電電阻

Metal Case / Internal Protective Device / Internal Discharge Resistors

特點 / FEATURES

油式低壓電容器採用鋼板烤漆外箱，電容器元件經過高真空含浸處理，溫昇低，使用壽命特長、耐候性佳。

- ◆ 自復性機能、介質損失小、溫昇低。
- ◆ 特性好、散熱佳、壽命長，特別適於濾波回路。
- ◆ 保安性：內部裝有保安裝置，具有防爆性能，防止二次災害發生。
- ◆ 採用無公害絕緣油（non-PCB）。

Oil type low voltage power capacitors use metal case. Capacitor elements are impregnated in high vacuum, low temperature rise, thus they have long life expectancy and can be operated at high ambient temperature. Some other features as following:

- ◆ Self-healing mechanism, low dissipation factor, low temperature rise, long service life.
- ◆ Good electrical characteristic, the best heat dissipation, and long service life; particularly suited for use in filter circuit.
- ◆ Safety: Internal protective device to prevent capacitor from bursting and avoid the relative disaster.
- ◆ Use environment friendly insulation oil (non-PCB)



保安裝置動作原理 / Operation of Internal Protective Device

當電容器過電壓使用或壽命即將終了前，會產生一連串自復性崩潰導致電容器內部壓力增大，為避免造成電容器外殼爆裂，電容器內部結構設計有電源切斷機構。此保護機構是在電容器內部兩條引出線作弱點處理及設計，由於內壓增加造成外箱膨脹使弱點處理處被拉斷與電源隔離，防止二次災害發生。

In the event of internal failure or aging at the end of the capacitor's operational life, an increasing number of self-healing breakdowns may cause rising pressure inside the capacitor. To prevent it from bursting, the capacitor is designed with break action mechanism. With rising pressure the case begins to expand. As a result, the two wires with safety mechanism are separated at the weak points, and the current path is interrupted irreversibly.

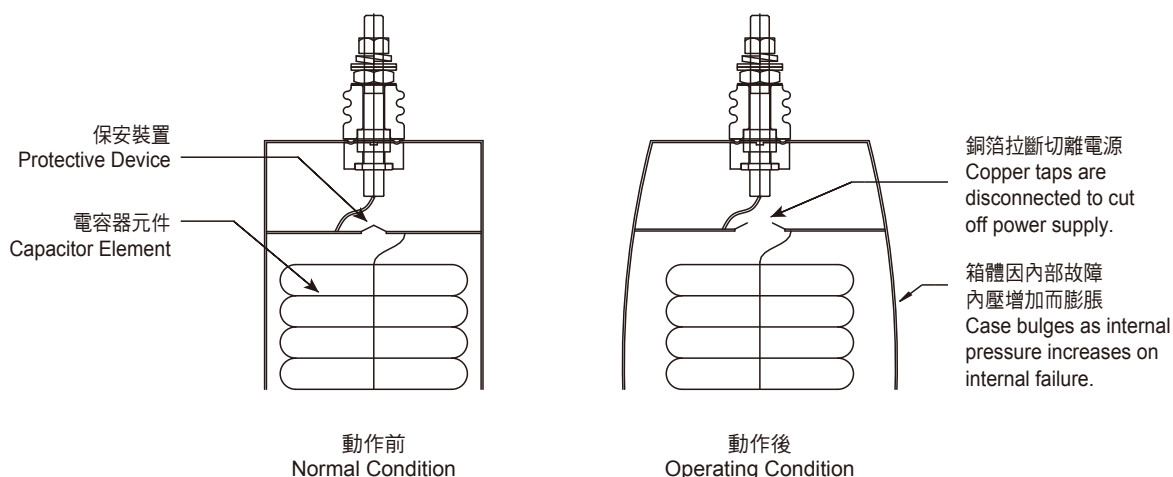

外形圖 / Outline Drawing

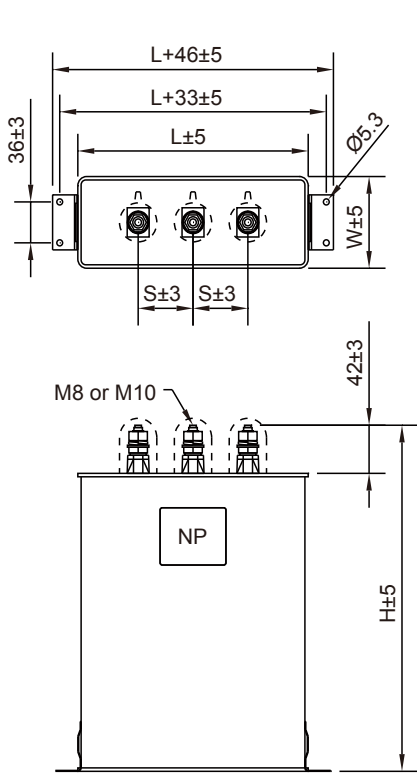

Fig. 1

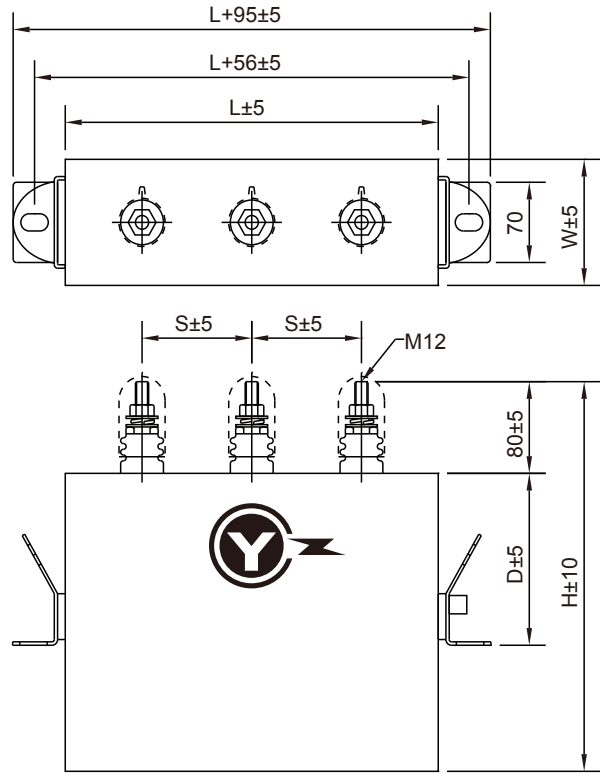

Fig. 2

260V 3Ø 60Hz

型式 Type	額定容量 Capacity		額定電流 Current (A)	尺寸 Size (mm)					接線 端子 Line terminals	概略 重量 kg	參考圖 Diagram
	kVAR	µF		L	W	H	D	S			
YSMA-26K10T	10	392	22.2	140	65	252	-	40	M8	2.6	Fig. 1
YSMA-26K15T	15	589	33.3	140	65	342	-	40	M8	3.7	Fig. 1
YSMA-26K20T	20	785	44.4	210	80	272	-	50	M8	4.8	Fig. 1
YSMA-26K25T	25	981	55.5	210	80	312	-	50	M10	5.7	Fig. 1
YSMA-26K30T	30	1177	66.6	210	80	362	-	50	M10	6.7	Fig. 1
YSMA-26K40T	40	1570	88.8	340	110	290	120	100	M12	11.8	Fig. 2
YSMA-26K50T	50	1962	111	340	110	320	120	100	M12	13.4	Fig. 2
YSMA-26K75T	75	2943	167	340	110	400	150	100	M12	17.7	Fig. 2

適用條件：系統電壓220V，APFR控制，有串聯6%或8%電抗器時，或諧波含量較高時。
 Condition: Line voltage 220V, controlled by APFR, with 6% or 8% series reactors, or higher harmonics.



油式低壓電容器 《保安型》 >>>>

金屬外箱 / 內裝保安裝置 / 內附放電電阻

Metal Case / Internal Protective Device / Internal Discharge Resistors

280V 3Ø 60Hz

型 式 Type	額定容量 Capacity		額定電流 Current (A)	尺 寸 Size (mm)					接線 端子 Line terminals	概略 重量 kg	參考圖 Diagram
	kVAR	μ F		L	W	H	D	S			
YSMA-28K10T	10	338	20.6	140	65	232	-	40	M8	2.3	Fig. 1
YSMA-28K15T	15	507	30.9	140	65	322	-	40	M8	3.4	Fig. 1
YSMA-28K20T	20	677	41.2	210	80	252	-	50	M8	4.4	Fig. 1
YSMA-28K25T	25	846	51.6	210	80	282	-	50	M10	5.1	Fig. 1
YSMA-28K30T	30	1015	61.9	210	80	322	-	50	M10	5.9	Fig. 1
YSMA-28K40T	40	1353	82.5	340	110	270	120	100	M12	10.7	Fig. 2
YSMA-28K50T	50	1692	103	340	110	300	120	100	M12	12.3	Fig. 2
YSMA-28K75T	75	2537	155	340	110	370	150	100	M12	16.1	Fig. 2

適用條件：系統電壓220V，APFR控制，有串聯8%或13%電抗器時，或諧波含量較高時。

Condition : Line voltage 220V, controlled by APFR, with 8% or 13% series reactors, or higher harmonics.

440V 3Ø 60Hz

型 式 Type	額定容量 Capacity		額定電流 Current (A)	尺 寸 Size (mm)					接線 端子 Line terminals	概略 重量 kg	參考圖 Diagram
	kVAR	μ F		L	W	H	D	S			
YSMA-44K10T	10	137	13.1	140	65	232	-	40	M8	2.3	Fig. 1
YSMA-44K15T	15	206	19.7	140	65	312	-	40	M8	3.2	Fig. 1
YSMA-44K20T	20	274	26.2	210	80	242	-	50	M8	4.1	Fig. 1
YSMA-44K25T	25	343	32.8	210	80	272	-	50	M8	4.8	Fig. 1
YSMA-44K30T	30	411	39.4	210	80	292	-	50	M8	5.3	Fig. 1
YSMA-44K40T	40	548	52.5	210	80	352	-	50	M10	6.7	Fig. 1
YSMA-44K50T	50	685	65.6	230	95	332	-	50	M10	7.4	Fig. 1
YSMA-44K75T	75	1028	98.4	340	110	350	150	100	M12	15.0	Fig. 2
YSMA-44K100T	100	1370	131	340	110	410	150	100	M12	18.2	Fig. 2

適用條件：系統電壓380V，單獨裝設，有諧波回路，APFR控制，或有串聯6%電抗器時。

Conditions : Line voltage 380V, Single equipped with circuit, circuit with harmonics, controlled by APFR, or with 6% series reactors.



480V 3Ø 60Hz

型式 Type	額定容量 Capacity		額定電流 Current (A)	尺寸 Size (mm)					接線 端子 Line terminals	概略 重量 kg	參考圖 Diagram
	kVAR	µF		L	W	H	D	S			
YSMA-48K10T	10	115	12.0	140	65	282	-	40	M8	2.8	Fig. 1
YSMA-48K15T	15	173	18.0	140	65	342	-	40	M8	3.6	Fig. 1
YSMA-48K20T	20	230	24.1	210	80	242	-	50	M8	4.2	Fig. 1
YSMA-48K25T	25	288	30.1	210	80	272	-	50	M8	4.8	Fig. 1
YSMA-48K30T	30	345	36.1	210	80	302	-	50	M8	5.5	Fig. 1
YSMA-48K40T	40	461	48.1	210	80	362	-	50	M10	6.8	Fig. 1
YSMA-48K50T	50	576	60.1	230	95	342	-	50	M10	7.7	Fig. 1
YSMA-48K75T	75	863	90.2	340	110	360	150	100	M12	15.5	Fig. 2
YSMA-48K100T	100	1151	120	340	110	420	150	100	M12	18.7	Fig. 2

適用條件：系統電壓380V，APFR控制，有串聯6%或8%電抗器時，或諧波含量較高時。
 Conditions : Line voltage 380V, controlled by APFR, with 6% or 8% series reactors, or higher harmonics.

525V 3Ø 60Hz

型式 Type	額定容量 Capacity		額定電流 Current (A)	尺寸 Size (mm)					接線 端子 Line terminals	概略 重量 kg	參考圖 Diagram
	kVAR	µF		L	W	H	D	S			
YSMA-52K10T	10	96	11.0	140	65	302	-	40	M8	3.1	Fig. 1
YSMA-52K15T	15	144	16.5	210	80	232	-	50	M8	3.9	Fig. 1
YSMA-52K20T	20	192	22.0	210	80	272	-	50	M8	4.8	Fig. 1
YSMA-52K25T	25	241	27.5	210	80	312	-	50	M8	5.6	Fig. 1
YSMA-52K30T	30	289	33.0	210	80	352	-	50	M8	6.5	Fig. 1
YSMA-52K40T	40	385	44.0	230	95	332	-	50	M8	7.4	Fig. 1
YSMA-52K50T	50	481	55.0	230	95	382	-	50	M10	8.7	Fig. 1
YSMA-52K75T	75	722	82.5	340	110	400	150	100	M12	17.4	Fig. 2
YSMA-52K100T	100	962	110	340	110	480	150	100	M12	21.7	Fig. 2

適用條件：系統電壓380V，APFR控制，有串聯8%或13%電抗器時，或諧波含量很高時。
 Conditions : Line voltage 380V, controlled by APFR, with 8% or 13% series reactors, or very high harmonics.

備註:其他規格均可代為設計製造 (Note:Other specification available on request)



乾式低壓電容器 (鐵殼M型) >>>>>

金屬外殼 / 內裝保安裝置 / 附放電電阻 / 屋內型
Metal Case / Internal Protective Device / Built-in Discharge
Resistors / Indoor Use

特點 / FEATURES

《M型》乾式低壓電容器採用鋼板烤漆外殼，具有防爆性、防火性及耐候性方面等絕佳效果，以立式外型方式生產，方便於配電盤內彙集較多數量電容器大容量之安裝使用，為節省空間、降低使用成本之理想設計。具有下列優點：

- ◆ 具自復機能、介質損失小、溫升低、壽命長。
- ◆ 保安性：每一電容器元件內部個別裝有保安裝置。
- ◆ 外殼採用鋼板衝壓而成，防爆防火。
外部塗上耐候性良好之高溫烤漆，整齊美觀。
- ◆ 體積小、節省空間，降低使用成本。

M-series dry-type low voltage power capacitor uses lacquered metal case having excellent anti-explosion, anti-fire and against climate change characters. Its vertical box shape is convenient for assembling multiple units to get bigger capacity, and is the best design for saving space and cost down. There are following merits:

- ◆ Self-healing mechanism, low dissipation factor, low temperature rise, long service life.
- ◆ Safety: each capacitor element equipped internal protective device.
- ◆ Metal case is made of steel sheet for anti-explosion, anti-fire. Anti-climate change and high temperature resistant lacquer is applied, that keeps the capacitor neat and pretty.
- ◆ Small dimensions reduce the demand space and installation costs.



保安裝置動作原理 / Operation of Internal Protective Device

當電容器內部故障或壽命即將終了前，會產生一連串自復性崩潰導致電容器元件內部壓力增大，為避免造成電容器外殼爆裂，每一電容器元件內部結構設計有壓力拉斷型電源切斷機構(保安裝置)。此保安裝置是藉由內壓增加造成上蓋鼓起使弱點處理之銅箔被拉斷與電源隔離，防止二次災害發生。

In the event of internal failure or aging at the end of the capacitor's operational life, an increasing number of self-healing breakdowns may cause rising pressure inside the capacitor element. To prevent it from bursting, each capacitor element is designed with internal pressure sensitive interrupter (Protective Device). With rising pressure the cover will bulge to disconnecting copper taps at weak points from the cover, and the current path is interrupted irreversibly to avoid the relative disaster.

電容器上蓋平整銅箔與上蓋端子連接
Capacitor cover is normally flat and the taps are connected to the cover.

保安裝置 / Protective Device

具弱點處理銅箔
Copper taps with weak point

電容器元件 Capacitor roll

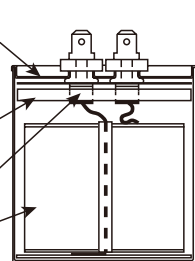

正常使用時(動作前)
Normal Condition

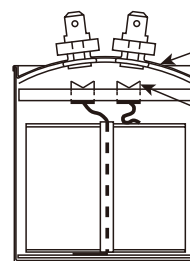

動作後
Operating Condition

電容器內部故障內壓上升上蓋鼓起
Capacitor cover bulges as internal pressure increases on the event of an internal failure.

銅箔被拉斷與上蓋分離
Copper taps are disconnected from the cover by the pressure sensitive interrupter.

外形圖 / Outline Drawing

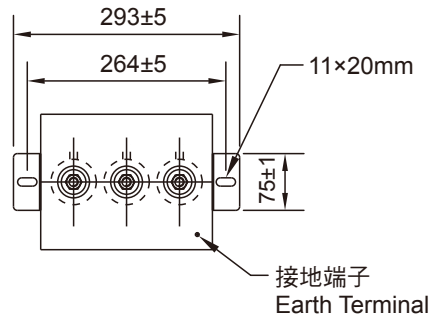
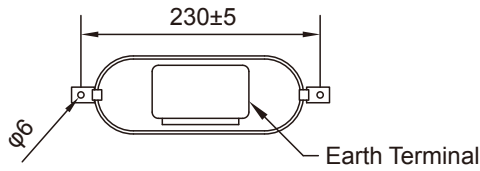

端子 Terminal	T
M8	42
M10	55
M12	60

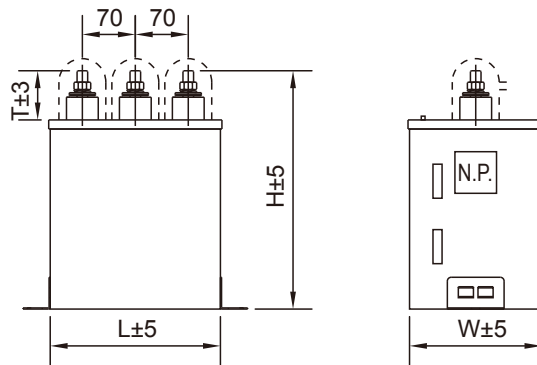
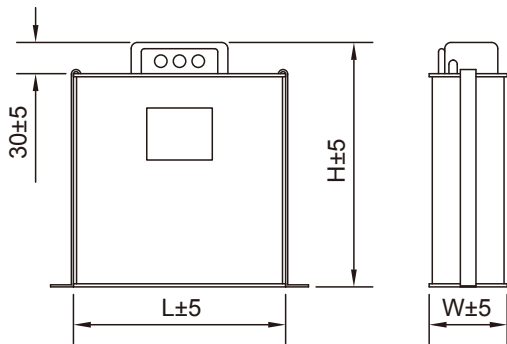

Fig. 1

Fig. 2

260V 3Ø 60Hz

型式 Type	額定容量 Capacity		額定電流 Current (A)	尺寸 Size (mm)			接線 端子 Line terminals	概略 重量 kg	參考圖 Diagram
	kVAR	μF		L	W	H			
YRMA-26K05TDM	5	196	11.1	205	75	235	M5	1.5	Fig.1
YRMA-26K10TDM	10	392	22.2	205	75	235	M5	1.9	Fig.1
YSMA-26K15TDM	15	589	33.3	225	175	232	M8	4.9	Fig.2
YSMA-26K20TDM	20	785	44.4	225	175	232	M8	5.2	Fig.2
YSMA-26K25TDM	25	981	55.5	225	175	245	M10	5.8	Fig.2
YSMA-26K30TDM	30	1177	66.6	225	175	305	M10	7.1	Fig.2
YSMA-26K40TDM	40	1570	88.8	225	175	380	M12	8.1	Fig.2
YSMA-26K50TDM	50	1962	111	225	175	380	M12	9.8	Fig.2

適用條件：系統電壓220V，APFR控制，有串聯6%或8%電抗器時，或諧波含量較高時。
 Conditions：Line voltage 220V, controlled by APFR, with 6% or 8% series reactors, or higher harmonics.



乾式低壓電容器 (鐵殼M型) >>>>

金屬外殼 / 內裝保安裝置 / 附放電電阻 / 屋內型
Metal Case / Internal Protective Device / Built-in Discharge Resistors / Indoor Use

280V 3Ø 60Hz

型 式 Type	額定容量 Capacity		額定電流 Current (A)	尺 寸 Size (mm)			接線 端子 Line terminals	概略 重量 kg	參考圖 Diagram
	kVAR	μF		L	W	H			
YRMA-28K05TDM	5	169	10.3	205	75	235	M5	1.6	Fig.1
YRMA-28K10TDM	10	338	20.6	205	75	235	M5	2.0	Fig.1
YRMA-28K15TDM	15	507	30.9	205	75	235	M5	2.1	Fig.1
YSMA-28K20TDM	20	677	41.2	225	175	232	M8	5.1	Fig.2
YSMA-28K25TDM	25	846	51.6	225	175	245	M10	5.5	Fig.2
YSMA-28K30TDM	30	1015	61.9	225	175	245	M10	5.8	Fig.2
YSMA-28K40TDM	40	1353	82.5	225	175	310	M12	7.7	Fig.2
YSMA-28K50TDM	50	1692	103	225	175	380	M12	9.4	Fig.2

適用條件：系統電壓220V，APFR控制，有串聯8%或13%電抗器時，或諧波含量很高時。

Conditions : Line voltage 220V, controlled by APFR, with 8% or 13% series reactors, or very high harmonics.

440V 3Ø 60Hz

型 式 Type	額定容量 Capacity		額定電流 Current (A)	尺 寸 Size (mm)			接線 端子 Line terminals	概略 重量 kg	參考圖 Diagram
	kVAR	μF		L	W	H			
YRMA-44K05TDM	5	69	6.56	205	75	235	M5	1.5	Fig.1
YRMA-44K10TDM	10	137	13.1	205	75	235	M5	1.8	Fig.1
YRMA-44K15TDM	15	206	19.7	205	75	235	M5	2.0	Fig.1
YSMA-44K20TDM	20	274	26.2	225	175	232	M8	4.9	Fig.2
YSMA-44K25TDM	25	343	32.8	225	175	232	M8	5.2	Fig.2
YSMA-44K30TDM	30	411	39.4	225	175	232	M8	5.5	Fig.2
YSMA-44K40TDM	40	548	52.5	225	175	305	M10	7.2	Fig.2
YSMA-44K50TDM	50	685	65.6	225	175	305	M10	7.8	Fig.2
YSMA-44K75TDM	75	1028	98.4	225	175	450	M12	11.6	Fig.2
YSMA-44K100TDM	100	1370	131	225	175	520	M12	14.3	Fig.2

適用條件：系統電壓380V，單獨裝設，有諧波回路，APFR控制，或有串聯6%電抗器時。

Conditions : Line voltage 380V, Single equipped with circuit, circuit with harmonics, controlled by APFR, or with 6% series reactors.



480V 3Ø 60Hz

型式 Type	額定容量 Capacity		額定電流 Current (A)	尺寸 Size (mm)			接線 端子 Line terminals	概略 重量 kg	參考圖 Diagram
	kVAR	µF		L	W	H			
YRMA-48K05TDM	5	58	6.01	205	75	235	M5	1.6	Fig.1
YRMA-48K10TDM	10	115	12.0	205	75	235	M5	2.0	Fig.1
YRMA-48K15TDM	15	173	18.0	205	75	235	M5	2.1	Fig.1
YSMA-48K20TDM	20	230	24.1	225	175	232	M8	5.0	Fig.2
YSMA-48K25TDM	25	288	30.1	225	175	232	M8	5.3	Fig.2
YSMA-48K30TDM	30	345	36.1	225	175	232	M8	5.6	Fig.2
YSMA-48K40TDM	40	461	48.1	225	175	305	M10	7.3	Fig.2
YSMA-48K50TDM	50	576	60.1	225	175	305	M10	7.9	Fig.2
YSMA-48K75TDM	75	863	90.2	225	175	450	M12	11.8	Fig.2
YSMA-48K100TDM	100	1151	120	225	175	520	M12	14.2	Fig.2

適用條件：系統電壓380V，APFR控制，有串聯6%或8%電抗器時，或諧波含量較高時。
 Conditions : Line voltage 380V, controlled by APFR, with 6% or 8% series reactors, or higher harmonics.

525V 3Ø 60Hz

型式 Type	額定容量 Capacity		額定電流 Current (A)	尺寸 Size (mm)			接線 端子 Line terminals	概略 重量 kg	參考圖 Diagram
	kVAR	µF		L	W	H			
YRMA-52K05TDM	5	48	5.50	205	75	235	M5	1.5	Fig.1
YRMA-52K10TDM	10	96	11.0	205	75	235	M5	1.9	Fig.1
YSMA-52K15TDM	15	144	16.5	225	175	232	M8	4.9	Fig.2
YSMA-52K20TDM	20	192	22.0	225	175	232	M8	5.2	Fig.2
YSMA-52K25TDM	25	241	27.5	225	175	232	M8	6.3	Fig.2
YSMA-52K30TDM	30	289	33.0	225	175	292	M8	6.9	Fig.2
YSMA-52K40TDM	40	385	44.0	225	175	292	M8	7.6	Fig.2
YSMA-52K50TDM	50	481	55.0	225	175	375	M10	9.5	Fig.2
YSMA-52K75TDM	75	722	82.5	225	175	520	M12	13.6	Fig.2
YSMA-52K100TDM	100	962	110	225	175	590	M12	16.7	Fig.2

適用條件：系統電壓380V，APFR控制，有串聯8%或13%電抗器時，或諧波含量很高時。
 Conditions : Line voltage 380V, controlled by APFR, with 8% or 13% series reactors, or very high harmonics.

備註:其他規格均可代為設計製造 (Note:Other specification available on request)



充氣式乾式低壓電容器 (鋁殼C型) >>>>

圓型鋁質外殼 / 氮氣充填 / 內裝保安裝置 / 附放電電阻 / 屋內型
 Cylindrical Aluminum Case / N₂ Filling / Internal Protective Device /
 With Discharge Resistors / Indoor Use

特點 / FEATURES

《C型》充氣式乾式低壓電容器採用圓型鋁質外殼，具有體積小、防火性及耐候性方面等絕佳效果，為節省空間、降低使用成本之理想設計。具有下列優點：

- ◆ 乾式、氮氣充填、無污染環保產品
- ◆ 保安性：具自復性機能、電容器每相內裝壓力拉斷型保護裝置，具過載及故障保護機能
- ◆ 防觸電端子組，配線簡易
- ◆ 介質損失小，溫昇低，壽命長
- ◆ 外殼底部附固定兼接地螺栓，安裝簡便

C-series dry-type low voltage power capacitor uses aluminum can having compact volume, anti-fire and against climate change characters. This is the best design for saving space and cost down. There are following merits:

- ◆ Dry-type, N₂ (Nitrogen) filling, and non-pollution of environment friendly products.
- ◆ Safety : Self-healing mechanism, internal protective device (Overpressure tear-off fuse) with overload and failure protection for every phase.
- ◆ Against electric shock terminals, easy connection.
- ◆ Low dissipation factor, low temperature rise, long service life.
- ◆ The bottom of the can has a mounting stud for mounting and earthing at the same time, easy for installation.



外形圖 / Outline Drawing

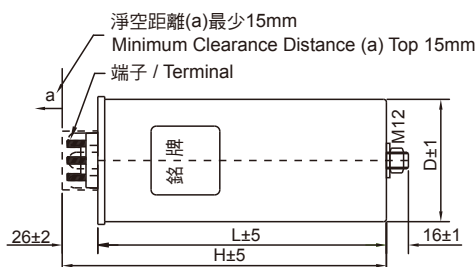
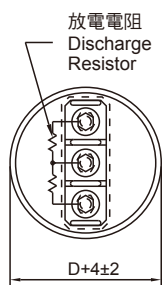
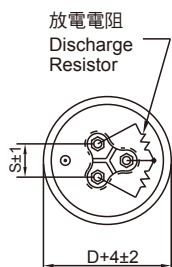

Fig. 1

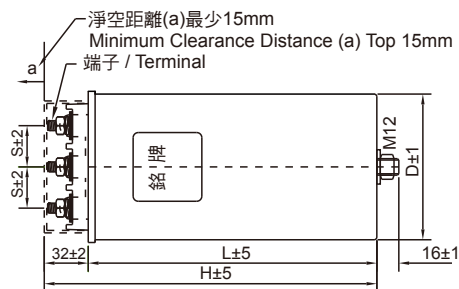

Fig. 2

260V 3Ø 60Hz

型式 Type	額定容量 Capacity		額定電流 Current (A)	尺寸 Size (mm)				接線 端子 Line terminals	概略 重量 kg	參考圖 Diagram
	kVAR	μF		D	L	H	S			
YYMA-26K05TGC	5	196	11.1	76	240	266	-	M6	0.96	Fig.1
YYMA-26K10TGC	10	392	22.2	96	240	272	22	M8	1.43	Fig.2
YYMA-26K15TGC	15	589	33.3	116	240	272	30	M8	1.95	Fig.2
YYMA-26K20TGC	20	785	44.4	136	240	272	30	M10	2.46	Fig.2
YYMA-26K25TGC	25	981	55.5	136	240	272	30	M10	2.82	Fig.2

適用條件：系統電壓220V，APFR控制，有串聯6%或8%電抗器時，或諧波含量較高時。
 Conditions : Line voltage 220V, controlled by APFR, with 6% or 8% series reactors, or higher harmonics.

280V 3Ø 60Hz

型 式 Type	額定容量 Capacity		額定電流 Current (A)	尺 寸 Size (mm)				接線 端子 Line terminals	概略 重量 kg	參考圖 Diagram
	kVAR	μF		D	L	H	S			
YYMA-28K05TGC	5	169	10.3	76	240	266	-	M6	0.91	Fig.1
YYMA-28K10TGC	10	338	20.6	96	240	272	22	M8	1.29	Fig.2
YYMA-28K15TGC	15	507	30.9	106	240	272	22	M8	1.71	Fig.2
YYMA-28K20TGC	20	677	41.2	116	240	272	30	M8	2.11	Fig.2
YYMA-28K25TGC	25	846	51.6	136	240	272	30	M10	2.57	Fig.2

適用條件：系統電壓220V，APFR控制，有串聯8%或13%電抗器時，或諧波含量很高時。

Conditions : Line voltage 220V, controlled by APFR, with 8% or 13% series reactors, or very high harmonics.

440V 3Ø 60Hz

型 式 Type	額定容量 Capacity		額定電流 Current (A)	尺 寸 Size (mm)				接線 端子 Line terminals	概略 重量 kg	參考圖 Diagram
	kVAR	μF		D	L	H	S			
YYMA-44K05TGC	5	69	6.56	76	240	266	-	M6	0.78	Fig.1
YYMA-44K10TGC	10	137	13.1	76	240	266	-	M6	1.05	Fig.1
YYMA-44K15TGC	15	206	19.7	96	240	272	22	M8	1.39	Fig.2
YYMA-44K20TGC	20	274	26.2	106	240	272	22	M8	1.69	Fig.2
YYMA-44K25TGC	25	343	32.8	116	240	272	30	M8	1.98	Fig.2
YYMA-44K30TGC	30	411	39.4	136	240	272	30	M10	2.35	Fig.2

適用條件：系統電壓380V，單獨裝設，有諧波回路，APFR控制，或有串聯6%電抗器時。

Conditions : Line voltage 380V, Single equipped with circuit, circuit with harmonics, controlled by APFR, or with 6% series reactors.

480V 3Ø 60Hz

型 式 Type	額定容量 Capacity		額定電流 Current (A)	尺 寸 Size (mm)				接線 端子 Line terminals	概略 重量 kg	參考圖 Diagram
	kVAR	μF		D	L	H	S			
YYMA-48K05TGC	5	58	6.01	76	240	266	-	M6	0.84	Fig.1
YYMA-48K10TGC	10	115	12.0	76	240	266	-	M6	1.08	Fig.1
YYMA-48K15TGC	15	173	18.0	96	240	272	22	M8	1.43	Fig.2
YYMA-48K20TGC	20	230	24.1	106	240	272	22	M8	1.73	Fig.2
YYMA-48K25TGC	25	288	30.1	116	240	272	30	M8	2.06	Fig.2
YYMA-48K30TGC	30	345	36.1	136	240	272	30	M10	2.44	Fig.2

適用條件：系統電壓380V，APFR控制，有串聯6%或8%電抗器時，或諧波含量較高時。

Conditions : Line voltage 380V, controlled by APFR, with 6% or 8% series reactors, or higher harmonics.

備註：其他規格均可代為設計製造 (Note: Other specification available on request)



- 1. 應考慮系統諧波含量，電容器應選用額定電壓較高之規格。
Consider harmonics in power system, the specification of capacitor should use higher rating voltage.
- 2. 如為自動功率因數調整盤時，因投切次數頻繁及湧入電流影響，每段電容器組應串聯電抗器使用，並提高電容器額定電壓等級。
In case of automatic power factor regulation bank, due to frequently switch in and out as well as the effect of inrush current, the capacitors should properly be equipped series reactors and use higher rating voltage specification.
- 3. 電容器串聯電抗器時應注意電容器壓升問題：
串聯6%電抗器時($X_L/X_C=6\%$)，電容器壓升6.38%。
串聯8%電抗器時，電容器壓升8.7%。
串聯13%電抗器時，電容器壓升14.94%
電容器壓升率 = $[(1 / (1 - X_L/X_C)) - 1] \times 100\%$
Consider voltage rise problem when capacitors connected with series reactors.
For 6% series reactor ($X_L/X_C=6\%$), capacitor voltage rise 6.38%
For 8% series reactor, capacitor voltage rise 8.7%
For 13% series reactor, capacitor voltage rise 14.94%
Capacitor voltage rise rate = $[(1 / (1 - X_L/X_C)) - 1] \times 100\%$
- 4. 電容器額定電壓提高後容量 (kVAR) 變化計算係數
Calculation coefficient for capacity (kVAR) variation after increasing rated voltage of capacitor

電容器額定電壓提高後容量 (kVAR) 變化計算係數 / Calculation coefficient for capacity (kVAR) variation after increasing rated voltage of capacitor

電容器提升後額定電壓(V) Increased capacitor rating voltage	原電容器額定電壓 (V) Original capacitor rating voltage						
	220	240	380	400	440	460	480
240	1.190	—	—	—	—	—	—
260	1.397	1.174	—	—	—	—	—
280	1.620	1.361	—	—	—	—	—
300	1.860	1.563	—	—	—	—	—
400	—	—	1.108	—	—	—	—
415	—	—	1.193	1.076	—	—	—
440	—	—	1.341	1.210	—	—	—
460	—	—	1.465	1.323	1.093	—	—
480	—	—	1.596	1.440	1.190	1.089	—
500	—	—	1.731	1.563	1.291	1.181	1.085
525	—	—	1.909	1.723	1.424	1.303	1.196
550	—	—	2.095	1.891	1.563	1.430	1.313
575	—	—	2.290	2.066	1.708	1.563	1.435
600	—	—	2.493	2.250	1.860	1.701	1.563
660	—	—	—	2.723	2.250	2.059	1.891
690	—	—	—	—	2.459	2.250	2.066

■ [範例]

原電容器額定電壓及容量為380V 50kVAR，提升電容器額定電壓為440V，則所需容量值為
50×1.341(由上表查得)=67kVAR

■ [Example]

Original capacitor rating voltage and capacity are 380V 50kVAR. If capacitor rating voltage is increased to 440V, the required capacity will become
50×1.341 (obtained from above table) =67kVAR

■ [公式/Formula]

$$\text{提升後容量值} = \text{原容量值} \times \left[\frac{\text{提升後額定電壓}}{\text{原額定電壓}} \right]^2$$

$$Q_2 = Q_1 \times \left(\frac{V_2}{V_1} \right)^2$$

V_1 : 原額定電壓 / Original rating voltage

V_2 : 提升後額定電壓 / Increased rating voltage

Q_1 : 原容量值 / Original capacitor(kVAR)

Q_2 : 提升後容量值 / Capacity of increased rating voltage



- 1. 應與易燃物隔離，裝設於無劇烈振動場所、乾燥、防塵、周圍溫度在45°C以下，通風良好之處所。
 - 2. 本電容器為屋內型，禁止裝設於日曬或雨淋之屋外場所。
 - 3. 安裝前必須充分考慮電容器投入後，所引起的電壓升高等因素，以防電容器在過電壓下長期運行。
 - 4. 在安裝電容器前，應注意檢測電力品質和電網特性，如存在諧波源（如非線性負載設備，整流器，電弧爐，感應爐，放電管等負載）的影響，應按諧波的嚴重程度，採取相應的措施加以限制。
 - 5. 安裝位置，愈接近負載效果愈好
 - 6. 電容器相互間距離應大於5公分；夏季環境溫度較高時，應採用有效措施，以確保通風散熱良好。
 - 7. 電容器之配線及分段設備之連續負載容量，不得低於額定電流之1.35倍。
 - 8. 配線時必須將導線確實鎖緊，避免接觸不良。
 - 9. 配合電容器用接觸器電流規格，建議選用電容器額定電流之1.5~1.8倍。
 - 10. 電容器與感應電動機並聯時，建議按電容器電流小於電動機空載電流90%來選配電容器。
 - 11. 電容器切離與再投入的時間間隔應大於3分鐘（自放電時間），否則可能產生很高的暫態過電壓，損壞電容器。
-
- 1. The capacitor should be secluded from combustibile material, and be installed on non-vibration, dry, dustproof, and good ventilated environment with maximum ambient temperature 45°C.
 - 2. The capacitor is designed for indoor use. DO NOT install at outdoor place with direct sunlight or rain.
 - 3. Before install capacitor, take into account the effect of voltage rise after capacitor switching in power system. In order to avoid capacitor continuously works in over voltage.
 - 4. Before install capacitor, check power quality and characteristics of power system. If system has harmonic sources (such as non-linear loads, inverters, arc furnaces, induction furnaces, or discharge lamps), proper limitation method should be used according harmonics level.
 - 5. The location of capacitor installation is more close to loads, much better for power factor correction.
 - 6. The distance between capacitors must be more than 50mm. For higher ambient temperature in summer, a proper method to get good ventilation shall be made.
 - 7. The rated current of connected wires and equipments for capacitor should not less than 135% of rated current of capacitor.
 - 8. Make sure the connection of wires to be screwed tight to avoid bad contacts.
 - 9. The rated current of contactor for capacitor is recommended 1.5 to 1.8 times of capacitor operating current.
 - 10. For capacitor, connector with induction motor in parallel, capacitor specification is recommended that capacitor current should be less than 90% non-load current of motor.
 - 11. The interval time for capacitor switching off to on must be more than 3 minutes to avoid capacitor damage by possible transient over voltage.



為使用安全，應實施以下項目的保養檢查 / (Please do the check items of maintenance for safety.)

檢查重點 / Check items	處 置 / Actions
溫升是否異常 Is temperature rise abnormal?	異常溫升 (15°C以上) 若非故障即為使用周溫 (最高45°C) 偏高，應究察原因。 If temperature rise is over 15°C, capacitor may be failure or ambient temperature too high (max. 45°C). Please find the cause.
有無生銹 Rustiness	應採取塗除銹塗料等防銹處理。 Using antirust paint
外箱有無爆裂 Is case cracked?	若出現爆裂現象，應立即更新電容器。 If case is cracked, replace new capacitor immediately.
有無淋水或滴水 Does there expose to the rain or drop with water?	改變設置地點。 Change location.
螺絲有無鬆動 Are there any screws loose?	振動是其原因。應改變設置地點或採取防振措施。 Vibration is a possible cause. Please change location, or do prevention against vibration.
有無鐵粉、塵埃堆積 Is it covered any iron powder or dust?	堆積很多時，應改變設置地點；堆積少時，可用刷子等清掃。 If accumulating too much, please change the location. If little accumulation, use brush to clean it.
外箱有無膨脹 Case expand	膨脹系因保安裝置起動所致。應究察電容器破壞的原因，並更新電容器。 Case expanded due to capacitor internal failure. Should check what caused capacitor failure and change the capacitor.

■ 日常巡視檢查：

藉目視檢查外殼是否破裂變形、異常響聲、火花、熔絲或斷路器是否正常、電線接頭過熱(膠皮變色)……等異常現象。

■ Daily Inspection:

Check if case has any cracks, or swelling, any abnormal sounds or sparks, any changes on color of insulation shields, or any other abnormal phenomenon.

■ 定期檢查：

保養工作須在切離電源經三分鐘，再將電容器短路後才可實施。

- (1)各螺絲接點的鬆緊和接觸情形(送電一週後實施)。
- (2)電容器及其附屬設備之積塵清掃。
- (3)電容器組的斷路器、保護裝置、饋電線、接地線……等是否良好。

(4)電容(μF)量測：

- a. 電容器電源切離3分鐘以上，完全放電後，以直讀式容量錶測量。
- b. 量測端子間容量值，得下列三個數據。
 $U-V=a$ $V-W=b$ $U-W=c$
 總容量= $(a+b+c) \times 2 \div 3$
- c. 正常情形
 容量量測值 $a \div b \div c \div$ 總容量的一半
 總容量在額定容量之-5%~+10%內。
 a, b, c值中最大值與最小值比率不得超過1.08。

■ Periodical maintenance:

Before any maintenance, switch off the power for 3 minutes, than short capacitor terminals.

- 1.) Check the condition of screws and contact points. (Implemented after power on for one week)
- 2.) Clean the capacitors and relative facility.
- 3.) Check the condition of breakers, protective devices, power lines, and ground wires for capacitors.
- 4.) Capacitance (μF) measurement:
 - a. Measure by capacitance meter after the capacitor de-energized for minimum 3 minutes and discharged completely.
 - b. Measure the capacitances between terminals to get 3 measured values as followings:
 $U-V=a$ $V-W=b$ $U-W=c$
 Total capacitance= $(a+b+c) \times 2 \div 3$
 - c. Normal conditions:
 The measured values are $a \div b \div c \div$ a half of total capacitance.
 Total capacitance should be within -5%~+10% of rated capacitance.
 The ratio of maximum to minimum value of a, b, and c values shall not exceed 1.08.





Calculation coefficients of capacity for capacitor to be installed

	改善後之功率因數 (Desired Corrected Power Factor) Cos θ ₂													
	1.00	0.99	0.98	0.97	0.96	0.95	0.94	0.93	0.92	0.91	0.90	0.85	0.80	
改善前之功率因數 (Original Power Factor) Cos θ ₁	0.50	1.73	1.59	1.53	1.48	1.44	1.40	1.37	1.34	1.31	1.28	1.25	1.11	0.98
0.52	1.64	1.50	1.44	1.39	1.35	1.31	1.28	1.25	1.22	1.19	1.16	1.02	0.89	
0.55	1.52	1.38	1.32	1.27	1.23	1.19	1.16	1.12	1.09	1.06	1.03	0.90	0.77	
0.57	1.44	1.30	1.24	1.19	1.15	1.11	1.08	1.05	1.02	0.99	0.96	0.82	0.69	
0.60	1.33	1.19	1.13	1.08	1.04	1.01	0.97	0.94	0.91	0.88	0.85	0.71	0.58	
0.62	1.27	1.12	1.06	1.02	0.97	0.94	0.90	0.87	0.84	0.81	0.78	0.65	0.52	
0.65	1.17	1.03	0.97	0.92	0.88	0.84	0.81	0.77	0.74	0.71	0.69	0.55	0.42	
0.67	1.11	0.97	0.91	0.86	0.82	0.78	0.75	0.71	0.68	0.65	0.62	0.49	0.36	
0.70	1.02	0.88	0.82	0.77	0.73	0.69	0.66	0.63	0.59	0.57	0.54	0.40	0.27	
0.72	0.96	0.82	0.76	0.71	0.67	0.64	0.60	0.57	0.54	0.51	0.48	0.34	0.21	
0.75	0.88	0.74	0.68	0.63	0.59	0.55	0.52	0.49	0.46	0.43	0.40	0.26	0.13	
0.77	0.83	0.69	0.63	0.58	0.54	0.50	0.47	0.43	0.40	0.37	0.34	0.21	0.08	
0.80	0.75	0.61	0.55	0.50	0.46	0.42	0.39	0.36	0.32	0.29	0.27	0.13		
0.82	0.70	0.56	0.50	0.45	0.41	0.37	0.34	0.30	0.27	0.24	0.21	0.08		
0.85	0.62	0.48	0.42	0.37	0.33	0.29	0.26	0.23	0.19	0.16	0.14			
0.87	0.57	0.42	0.36	0.32	0.28	0.24	0.20	0.17	0.14	0.11	0.08			
0.90	0.48	0.34	0.28	0.23	0.19	0.16	0.12	0.09	0.06	0.03				
0.91	0.46	0.31	0.25	0.21	0.16	0.13	0.09	0.06	0.03					
0.92	0.43	0.28	0.22	0.18	0.13	0.10	0.06	0.03						
0.93	0.40	0.25	0.19	0.15	0.10	0.07	0.03							
0.94	0.36	0.22	0.16	0.11	0.07	0.03								
0.95	0.33	0.19	0.13	0.08	0.04									
0.96	0.29	0.15	0.09	0.04										
0.97	0.25	0.11	0.05											
0.98	0.20	0.06												
0.99	0.14													

- 使用例：設工廠負荷：200kW
改善前之功率因數：Cosθ₁=0.80
擬改善之功率因數：Cosθ₂=0.97
由上表查出所需電容量比率為0.50
故所需容量C=200x0.50=100kVAR

- Example:
Plant loading: 200kW
Power factor before improvement: Cosθ₁= 0.80
Expected power factor after improvement: Cosθ₂= 0.97
Coefficient according above table is 0.50
Required capacity is 200×0.5=100kVAR

- 容量電流計算公式
Formulas for capacity and current calculating
 $kVAR = 2\pi fCE^2 \times 10^{-3}$

$$C = \frac{kVAR}{2\pi fE^2 \times 10^{-3}}$$

$$A(1\phi) = \frac{kVAR}{E} = 2\pi fCE \times 10^{-3}$$

$$A(3\phi) = \frac{A(1\phi)}{\sqrt{3}}$$

$$\begin{aligned} \pi &= 3.1416 \\ f &= \text{Hz} \\ C &= \mu F \\ E &= kV \\ \sqrt{3} &= 1.732 \end{aligned}$$

■ 主要產品

1. 高壓電力用電容器
2. 油式/乾式低壓電容器
3. 高壓突波吸收電容器
4. 感應加熱爐用電容器
5. UV乾燥機用電容器
6. 自動功率因數調整盤
7. 自動功率因數調整器
8. 高低壓串聯電抗器
9. 馬達運轉用電容器
10. 照明燈具用電容器

■ Main Products

- High Voltage Power Capacitors
- Oil-type / Dry-type Low Voltage Capacitors
- High Voltage Surge Absorbing Capacitors
- Induction Heating Furnace Capacitors
- Capacitors for UV Curing Equipments
- Automatic Capacitors Banks
- Automatic Power Factor Regulators
- High / Low Voltage Series Reactors
- Motor Running Capacitors
- Lighting Capacitors



裕昌機電工廠股份有限公司 YUHCHANG ELECTRIC CO., LTD.

總公司:

台灣·台中市清水區43653中正街59號
Tel:886-4-26224188 Fax:886-4-26224646

台北聯絡處:

台北市大安區復興南路1段321號2樓之3
Tel:886-2-27021616 Fax:886-2-27066162

高雄聯絡處:

高雄市新興區復興一路5之1號
Tel:886-7-2417766 Fax:886-7-2915282

ADD : No. 59, Chung Cheng Street, Ching Shui District,
Taichung City 43653, Taiwan
Tel : +886-4-26224188 Fax:+886-4-26224646
Web : <http://www.capacitor.com.tw>
E-mail : yce919@ms1.hinet.net

